

Bauer Products, Inc.
702 Evergreen St SE
Grand Rapids, MI 49507
1-866-68-BAUER(22837)
(616) 245-4540
(616) 245-0131 fax

Bauer NE

Thank You for purchasing the ***Bauer NE***. We have developed the ***Bauer NE*** with the idea to increase your convenience and security. We are a family owned company with over 50 years of service in the locking hardware industry, and we are grateful for the opportunity to serve you. Please review and follow the Installation, Programming, and Operating Instructions to ensure proper function.

The *Bauer NE* features:

- The first self-contained electronic RV latch with Capacitive Touch Technology.
- An integral touch pad to the latch which controls the dead bolt.
- It is powered by 4 AA batteries.
- Is retrofitable in most RV entry doors, and is easy to install.
- Programmable with a 4 digit PIN number.
- The large buttons are easy to see and use.
- Proximity sensing which illuminates the buttons.
- An Intelligent Keyless Entry System which knows the position of the deadbolt and indicates low battery strength, as well as providing audible feedback to successful locking and unlocking functions.
- The key will always be able to operate the paddle or dead bolt lock in case of the user forgetting the code or dead battery

***Bauer NE* Installation Instructions:**

- The following steps are graphically shown on the enclosed ***Bauer NE*** Installation schematic.
 1. Remove old lock.
 2. Clean cut-out. Remove any dirt, loose material, etc.
 3. Install outside housing (the portion that includes the Touch Pad) with the dead bolt in the unlocked position.
 4. Attach the (2) 8x32 screws into the portion of the handle that has the Plunger and Dead Bolt. This is on the edge of the door.
 5. Plug wire from Inside Plate Assembly into the receptacle on the housing. **DO NOT PICK UP INSIDE PLATE ASSEMBLY BY PLUG.** Make sure to align the tab on the plug properly with the slot on the receptacle. The plug should make a slight click when properly engaged.
 6. Tuck Battery Wires into pocket next to Stamped Steel Plate. Do not allow Battery Wires to get between Inside Plate Assembly and Stamped Steel Plate as it will cause the motor to bind.
 7. Align the Dead Bolt Knob in the unlocked position. The Red Dots on the Dead Bolt Knob and the Inside Plate Assembly should be aligned to indicate the unlocked position of the Dead Bolt. Slide Dead Bolt Knob over D-Stem and align the 4 screw bosses on the housing with the attaching holes on the Inside Plate Assembly. When Inside Plate Assembly is in position with Housing install the (4) 8x32 Screws. Secure but do not over tighten screws.

Battery Installation:

The **Bauer NE** uses 4 AA batteries for operation. We do not recommend zinc carbon batteries for this application. Batteries not included.

Fresh batteries should be installed as necessary. Battery Life is highly dependent upon battery quality, usage, and environment (temperature). Remove batteries if the lock will not be used for extended periods of time.

The following steps are shown on the enclosed Battery Installation schematic.

1. Loosen (2) 6x32 Captured screws on Battery Compartment Lid. These screws are captured to the Battery Compartment Lid so they will not fall out.
2. Install the AA batteries in accordance with the orientation shown in the Battery Compartment. The batteries will fit tightly. Please verify the batteries are touching the contacts on both sides in the Battery Compartment.
3. Install Battery Compartment Lid by aligning the (3) tabs on the lid with the (3) slots on the Inside Plate Assembly. These tabs act as a hinge for closing the Battery Compartment Lid.
4. Tighten the (2) 6x32 Captured screws back to attach the Battery Compartment Lid to the Inside Plate Assembly.

Bauer NE Operation and Programming Guide:

Description

The **Bauer NE** is a 4 touch pad button programmable deadbolt lock. The 4 buttons are labeled "1|2", "3|4", "5|6", "7|8". The button labeled "1|2" is the same button whether the number 1 or 2 is desired. Please note this handle uses Touch Technology. The buttons are activated by Touch and does not require pressing the buttons. Touch the button and lift finger from button for proper code entry.

Operation

The **Bauer NE** incorporates proximity sensing to determine when you want to activate the lock. To operate the lock you first must "wake up" the lock. To "wake up" the lock you must touch the area next to the buttons. The buttons will illuminate once the Touch Pad is awakened. This indicates that the Touch Pad is ready for the code to be entered.

Preset Factory Code

The **Bauer NE** has a factory set code of 3,7,1,5 followed by the Enter button. The button

with the  symbol is the Enter button, and is required to be touched after the code is entered. The factory code resets every time the batteries are removed for at least 10 seconds.

Programming New Code

To set a new code, touch and hold the "3|4" button and the Enter Buttons for 2 seconds. The **Bauer NE** will provide three short beeps, indicating it is ready to accept a new code. Enter the new 4 digit code followed by

the . The **Bauer NE** will provide four short beeps to indicate new code has been entered. The first time the new 4 digit code is entered there will be a long beep indicating the new code is accepted. The new code can be entered now and will activate the dead bolt.

To reset the code, remove the batteries for at least 10 seconds. Re-install the batteries; and follow the steps to **Programming New Code.**

Quick Lock Feature – Look for Sticker Indicating this feature on Battery Compartment Lid

Once your personal code has been entered the **Bauer NE** can be locked by simultaneously touching both the “7|8” and the . Please note this feature is only activated once the personal code is entered.

Please Enter Personal Code upon Installation of Lock to prevent inadvertent programming.

Bauer NE Fault Logic**Action****Bauer NE Response**

Ready to Accept New Code	Three short beeps
New Code Entered	Four short beeps
Wrong Code Entered	One long beep
Dead Bolt Locks	Two short beeps
Dead Bolt Unlocks	Two short beeps
Dead Bolt fails to Lock	One long beep
Dead Bolt fails to Unlock	One long beep
Low Battery	Button Lights Blink during “wake up” and One Long beep after the Lock/Unlock beeps

The lock will cycle up to 10 more times once the low battery indication occurs. After this the final electric function in a low battery condition will be unlock and not lock until the batteries have been replaced. Please note that if the deadbolt is in the locked position and the batteries die the deadbolt will remain locked. The key will always be able to activate the deadbolt lock.

General Maintenance and Operating Guidelines

- Install fresh batteries as necessary. The **Bauer NE** is designed to function for months of normal usage with fresh, high quality AA batteries. Battery life is highly dependent upon battery quality, usage, and environment (temperature).
- Make sure there are no obstructions in the door frame to prevent Dead Bolt extension.
- Do not wash with power washer or high pressure cleaner. The Bauer NE is designed to resist water intrusion to protect its electrical components from normal water encounter such as rain.
- The **Bauer NE** uses Touch Technology. The buttons are activated by touching not pressing.
- Remove batteries when storing or not using this lock for extended periods of time.

Installation and Operation Videos available at
www.bauerproducts.com

Rain Sensing Technology

The **Bauer NE** possesses Rain Sensing Technology in order to preserve battery life. Please note rain will wake up the touch pad and illuminate the Buttons. After a few seconds of contact from rain (water) the lights will turn off, but a code still can be entered and the lock will function normally. The same effect will occur if the operator continues to touch the touch pad for a prolonged period of time. Initially the Buttons will illuminate, but then turn off. Again the lock will function normally in this case as well.

Additional Security Feature

The **Bauer NE** recognizes the first four digits entered as the code. However, if you feel someone is watching

you enter your code you can continue to enter digits after the first four prior to touching the enter button  For example, if your code is 8,1,3,9 and you felt as if you were being watched you would enter 8,1,3,9 then

continue to touch additional digits prior to touching the enter button  and the lock will operate.

Troubleshooting

<u>Problem</u>	<u>Possible Fixes</u>
After Installation the Touch Pad does not work	-Batteries are dead -Batteries are not installed properly -Plug not engaged properly
Dead Bolt not engaging into Door Frame	-Obstruction in Door Frame
Code not working	-Remove Batteries for 10 seconds then Program New Code
Inside Paddle not Opening Latch	-Inside screws are not secured to the Housing.
Buttons Light but Dead Bolt does not activate	-Replace Batteries

If the problem is not found on this list please call 1 866 682 2837 for assistance.

Limited Warranty

BAUER'S WARRANTY IS LIMITED. AT ITS SOLE DISCRETION, BAUER MAY EITHER REPLACE OR REPAIR ANY DEFECTIVE PARTS. IN NO EVENT SHALL BAUER HAVE ANY LIABILITY TO CUSTOMER FOR PAYING INCIDENTAL, SPECIAL OR CONSEQUENTIAL DAMAGES INCLUDING (WITHOUT LIMITATION) DAMAGES RESULTING FROM PERSONAL OR BODILY INJURY OR DEATH OR DAMAGES TO, OR LOSS OF USE OF, ANY PROPERTY. NOTWITHSTANDING ANY PROVISION TO THE CONTRARY, THIS LIMITED WARRANTY IS MADE UPON THE EXPRESS UNDERSTANDING THAT IT SHALL APPLY IN CONNECTION WITH THE SALE OF THE PRODUCT BY BAUER AND IS IN LIEU OF ALL OTHER WARRANTIES (EXPRESS, IMPLIED OR STATUTORY) INCLUDING THE SEPARATE WARRANTIES OF MERCHANTABILITY AND FITNESS FOR A PARTICULAR PURPOSE OR USE.

Bauer NE Installation

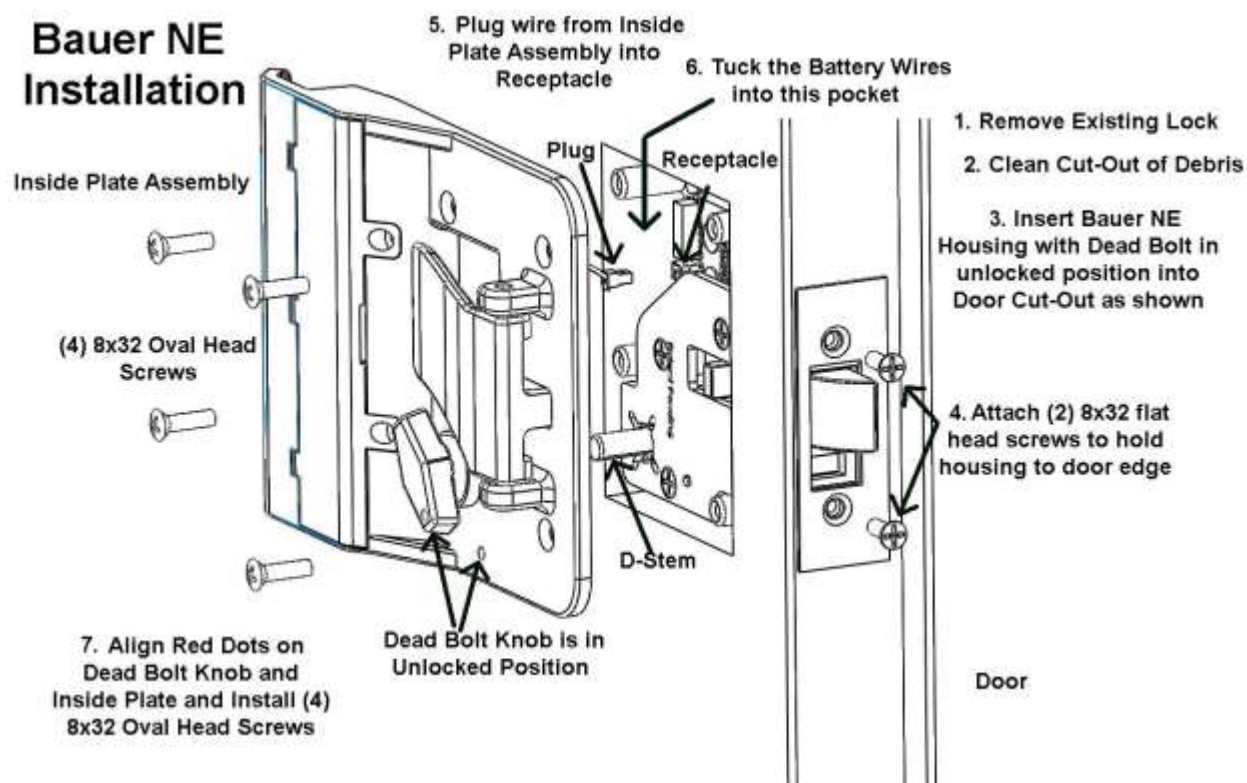

Battery Plug Instructions

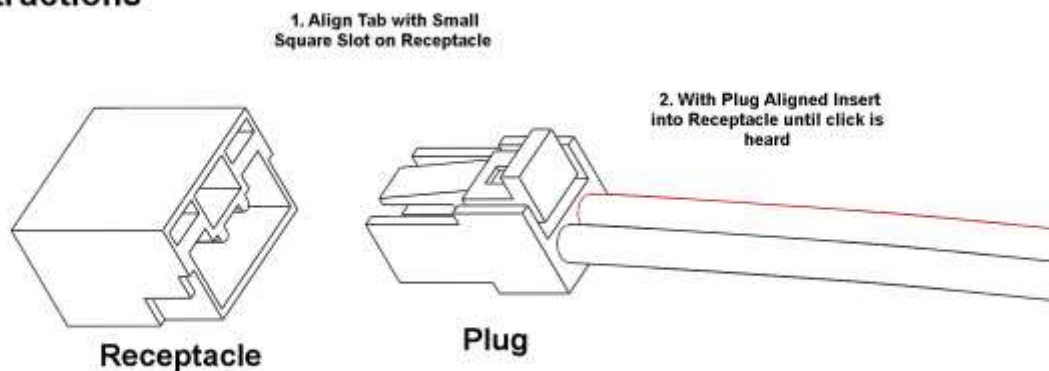

This is a detailed view of the Plug and Receptacle for plugging the Inside Plate Assembly into the Receptacle on the Bauer NE Housing.

Installation and Operation Videos available at
www.bauerproducts.com

Battery Installation

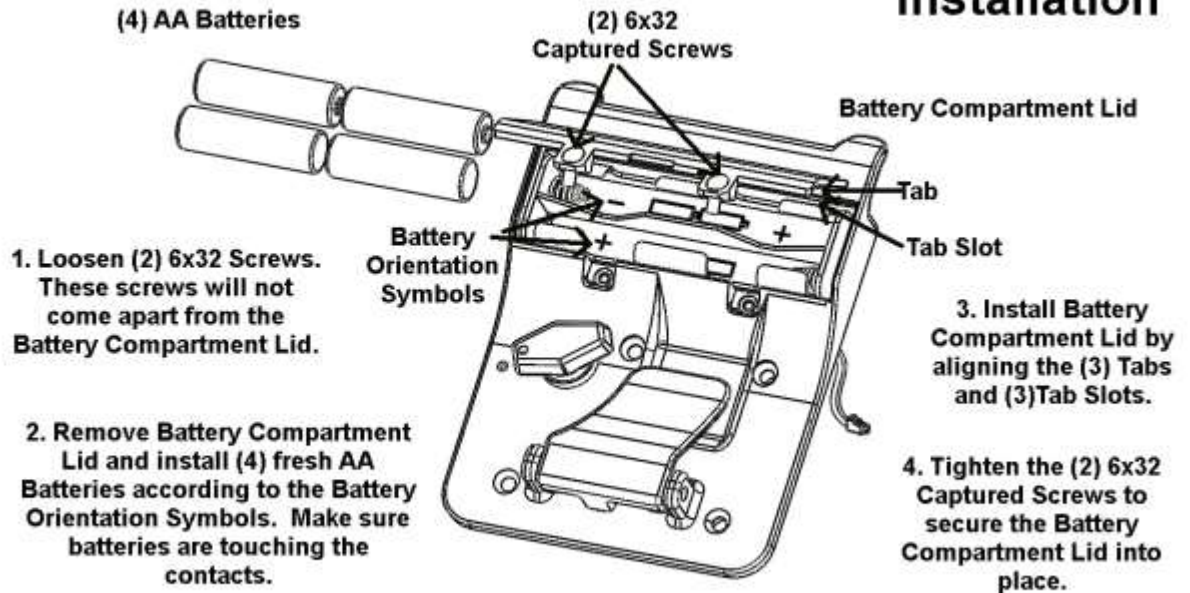

Bauer NE Operation

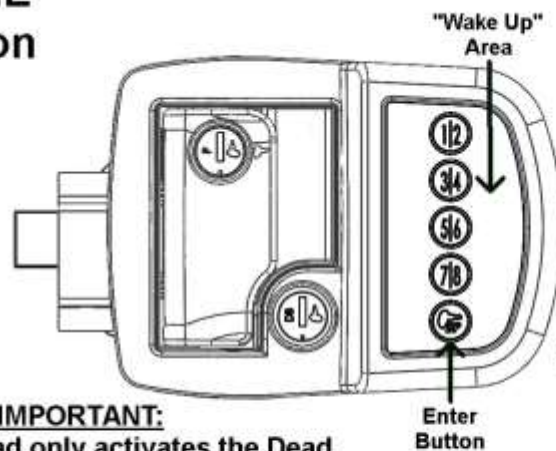

1. Touch the area next to the Buttons to "Wake Up" the lock.
2. The Buttons will illuminate when the lock is "awake" and ready to accept the code.
3. The factory default code is activated by touching the 3,7,1,5 Buttons followed by the Enter Button.
4. To program your Personal Code touch and hold the "3|4" Button and Enter Button for 2 seconds. The lock will beep 3 times indicating it is ready to accept a new code. Enter a 4 digit code followed by the Enter Button. The lock will beep 4 times to indicate a new code has been entered. The first time the new 4 digit code is entered there will be a long beep indicating the new code is accepted. The new code can be entered now and will activate the dead bolt.

IMPORTANT:

The Touch Pad only activates the Dead Bolt. The Paddle Lock is Master Keyed for Dealer and Service Center use. The Dead Bolt provides Maximum Security

Please enter your Personal Code upon installation of NE to prevent inadvertent programming.

Installation and Operation Videos available at
www.bauerproducts.com